

Dlimit™

DLIMIT



Specialists in safer public environments.

DLIMIT™

The most ecological barrier solution

The steel is 100% recyclable and is the basic element of this collection. The rest of the material is recycled or recyclable plastic.



All tubes in the Dlimit™ collection are made of steel. All are 100% recyclable.



Our polypropylene is made from 70% recycled materials and is 100% recyclable



Other polymers that we use for example Poliamida is fully recyclable while SBR is both 100% recycled and 100% recyclable.



All our packaging uses 90% recycled cardboard and is of course 100% recyclable.



Our products comply with the DDA regulations so that they are equally efficient for people with reduced mobility.



All inks and dyes we use in our sublimation process are water based and ecologically friendly.



This seal is applied to clothing or products of mixed composition. It certifies that a part of the fabric is made from recycled materials.



All products and raw materials used to produce Dlimit are made in Europe. This generates local economic activity and reduces our carbon footprint.



The strongest barrier solution

All the tubing in the Dlimit™ collection are Ø70mm steel with a 1.5mm wall. This increases their impact resistance.



The Dlimit™ is 99% recyclable steel, powder coated to protect it and extend its working life. With three tube models and six compatible bases, the Dlimit™ collection is the most versatile in our catalogue.

(*)All RAL colours available.

The safest barrier solution

We make the safest retractable barrier on the market.



One-way™ brake system (Patent pending). Controls the collection of the belt without generating any resistance during extension.



Steel one-directional spring, developed for collecting seat belts in cars, tested up to 200,000 collection cycles. (ISO 9001)



The belt terminal features a security button to prevent that the belt accidentally retract. (Optional)



The Dlimit™ collection offers six different bases covering a wide range of needs. In all cases the bases offer the correct weight and stability for each need.



The wall of the tube is 1.5mm thick making our post unbeatable being highly resistant to impact.

The most profitable barrier solution

Our models with 5m tape save both space and money.

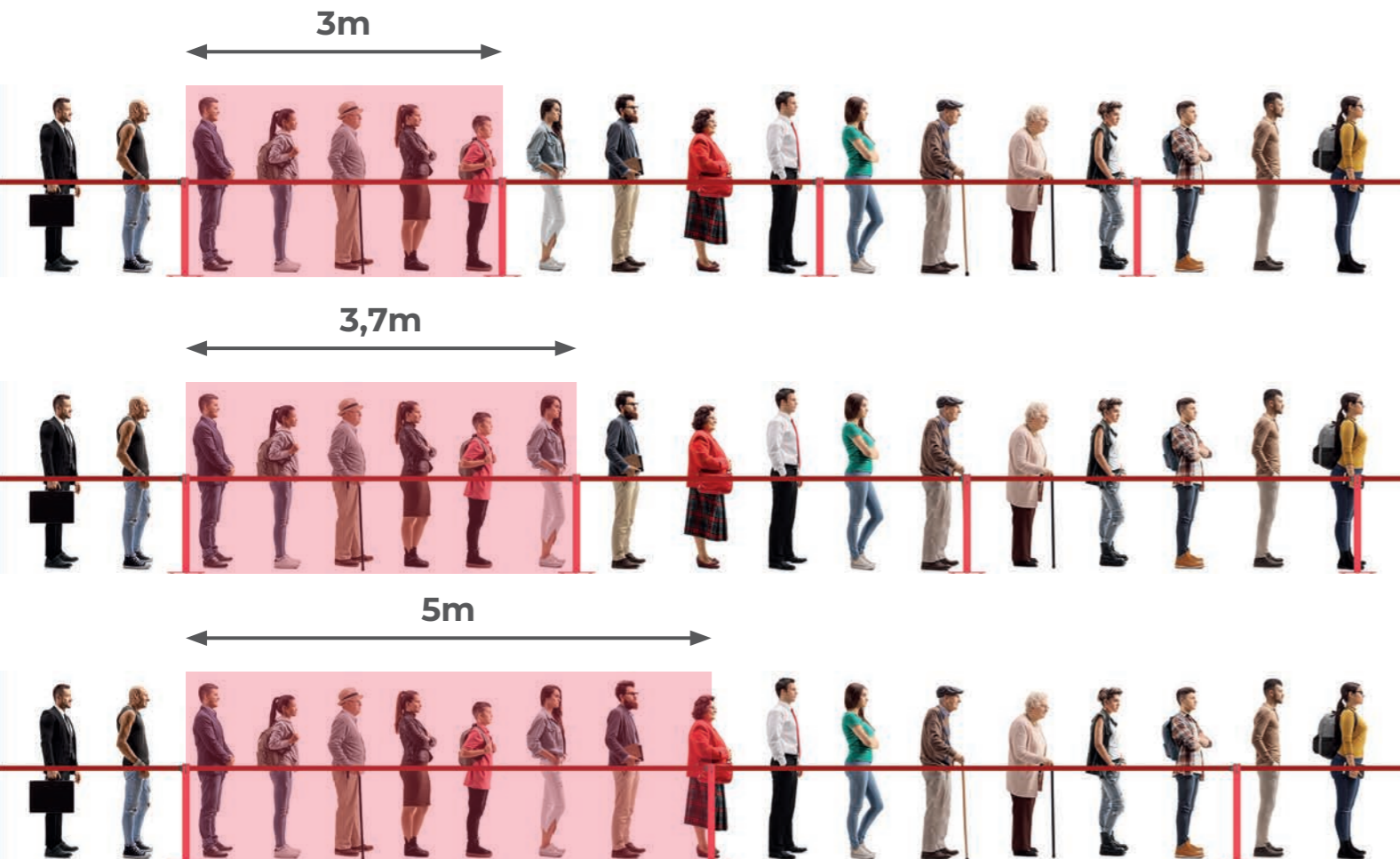

The most modern barrier solution

Dlimit™ is the new system to guide people. Notable are its ecologic credentials, simplicity, and the functionality of its exclusive design.

Models patented in EUIPO:
No. 006608147-0001
No. 006607248-0001

Security comes first

We make the most secure retractable barrier on the market. Our cassettes have a One-Way™ brake system (Patent pending), the most exclusive in the market. The tape retracts 2.5 seconds slower than that of our nearest competitor making Dstandard™ the safest solution for your clients.



Design & innovation

Dlimit™ is the leading barrier in the market due to its durability and safety. We design our products to be versatile as we know they will be used in diverse applications, all over the world. We offer key functions to all businesses, efficiency, profitability and safety.

CE Mark

Access to the European market. The CE mark guarantees common standards of safety, durability, energy efficiency and environmental protection standards throughout Europe. Our products are designed, developed and made in the EU.





Three options and all versatility

The collection Dlimit™ offers three post types, all compatible with the bases in the collection.

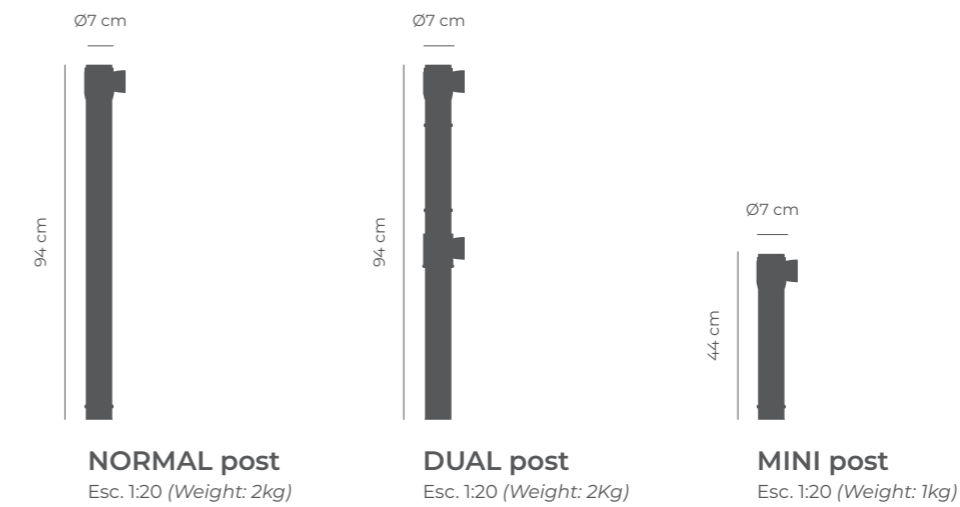

Two heights, three options

The **NORMAL post** is 94cm high and has a retractable tape.

The **DUAL post** is 94cm high and has two retractable tapes.

The **MINI post** is 44cm high and has a retractable tape.

In all the posts you can choose tape length of either 3m or 3.7m.

Four options for the tape terminal

Choose the terminal that best meets your needs.

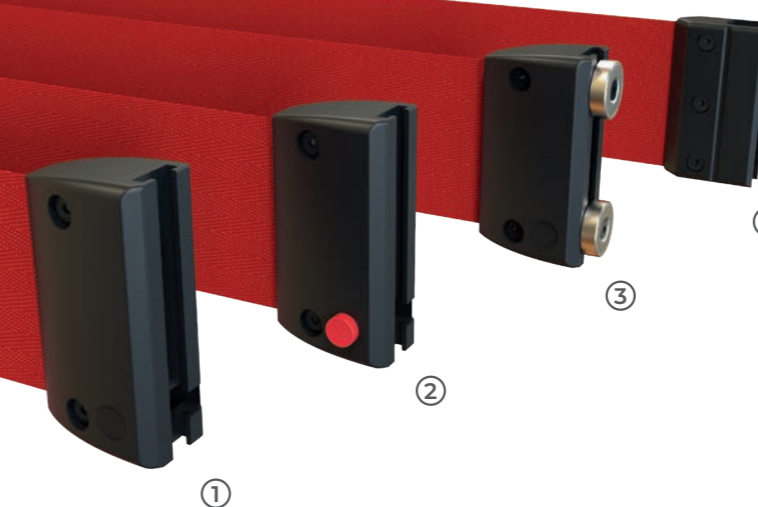

We adapt to you

The Dlimit™ posts offer four distinct tape closures or terminals.

1. Rapid closing. The simplest option, put and take, this is the default option for all our posts.

2. Safety closing. Incorporates a button that must be pressed to allow opening of the terminal.

3. Magnetic closing. Incorporates magnets to attach the tape to magnetic surfaces.

4. Antipanic closing. The tape is released only if it receives sufficient tension.



LIMIT base

This extra thin base is our signature option.

Steel construction. Diameter Ø36 cm, 1,5 cm thick, weight 6 kg. Has rubber studs to protect the floor.

Offered in stainless steel or powder coated.



LIMIT base

Our classic base,

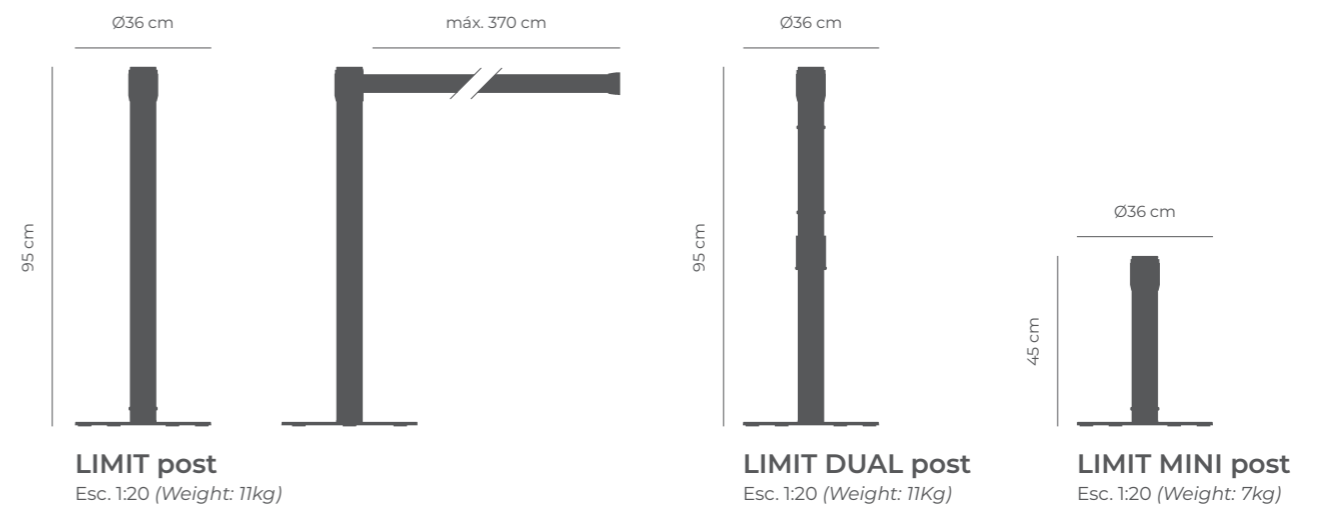



ECO base

This base is extra thin and is our most ecological and economic model.

Made from recycled PP, diameter Ø36 cm, 1,5 cm thick, weight 4.5kg.

Fitted with rubber studs to protect the floor.

Only offered in black.

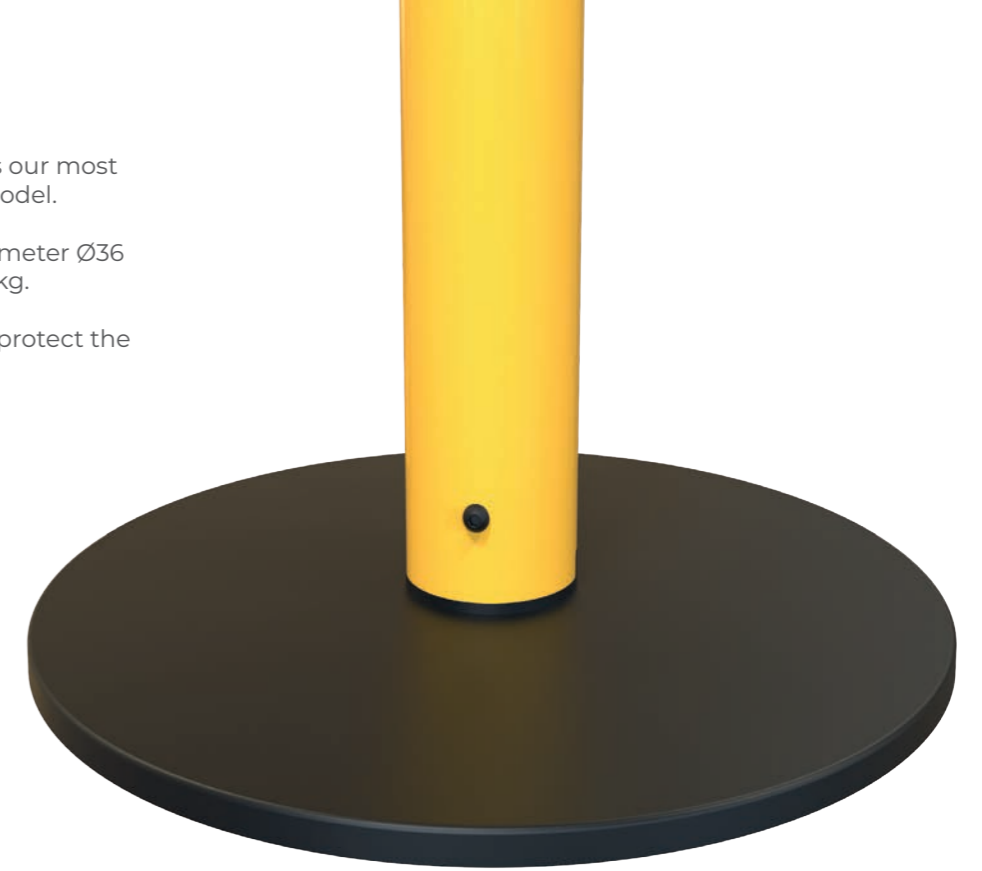

ECO base

A new economic and ecological base.

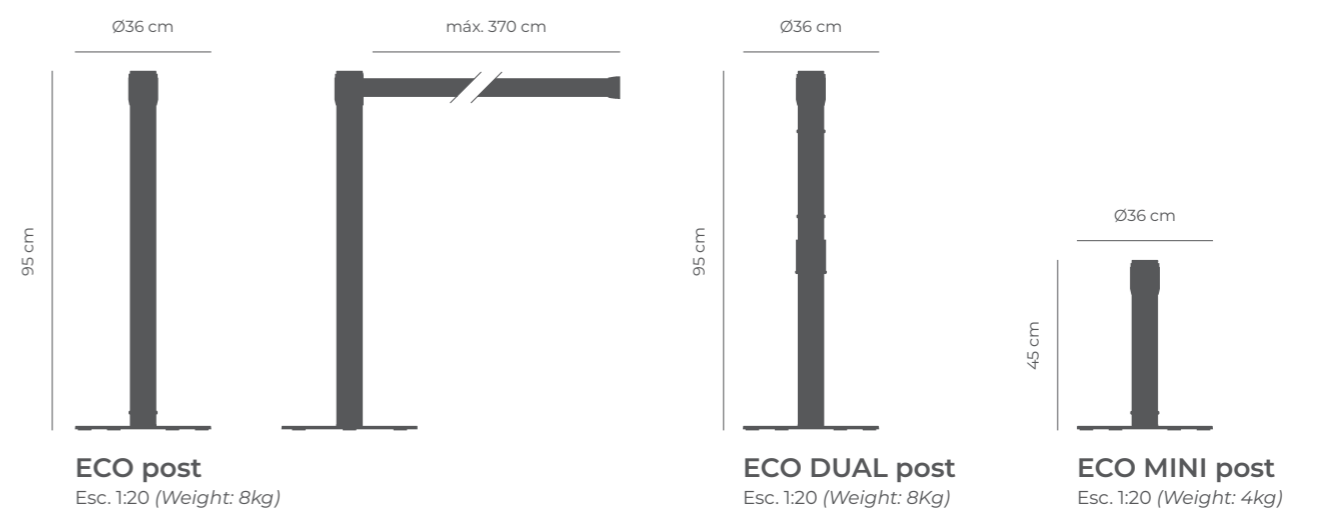



MAG base

Our magnetic base.

Steel construction with recycled PP core.

Diameter Ø 14cm, 2cm thickness and a weight of 1 kg.

Three neodymium magnets are embedded into its bottom surface offering a force of approximately 150kg.

The base includes a ferrous disc with a adhesive film to protect the floor.

Offered in stainless steel or powder coated finish.

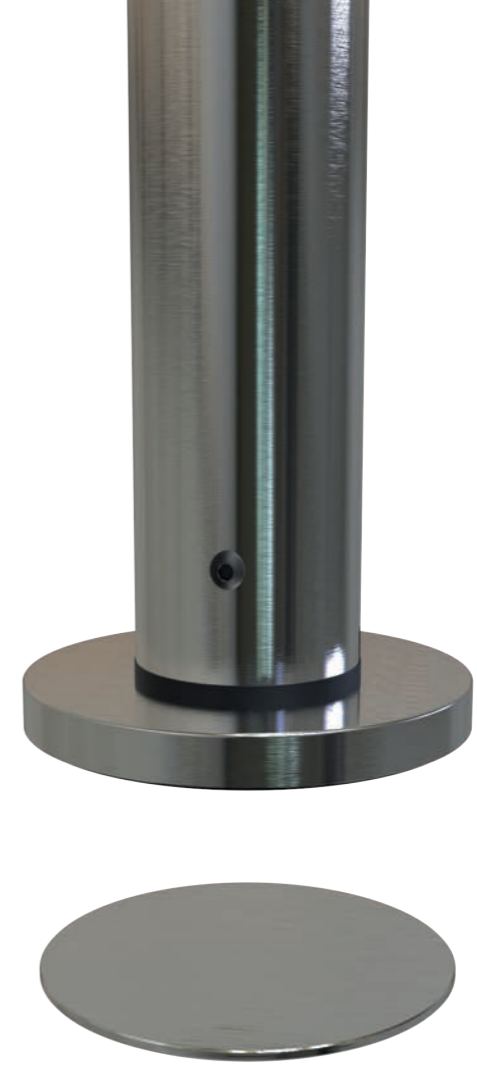

MAG base

The magnetic base.

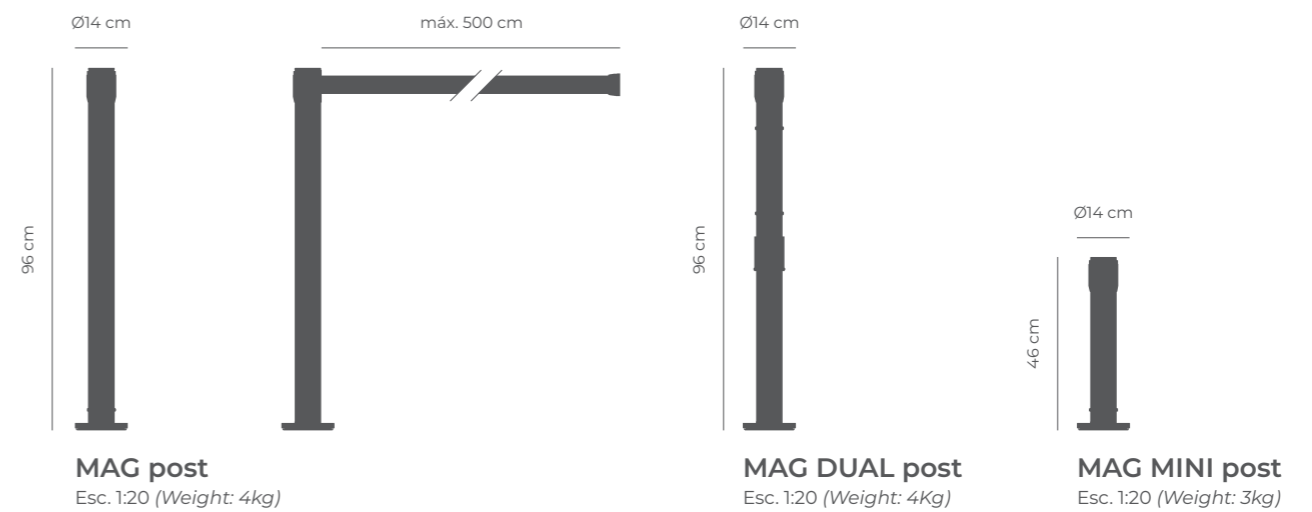

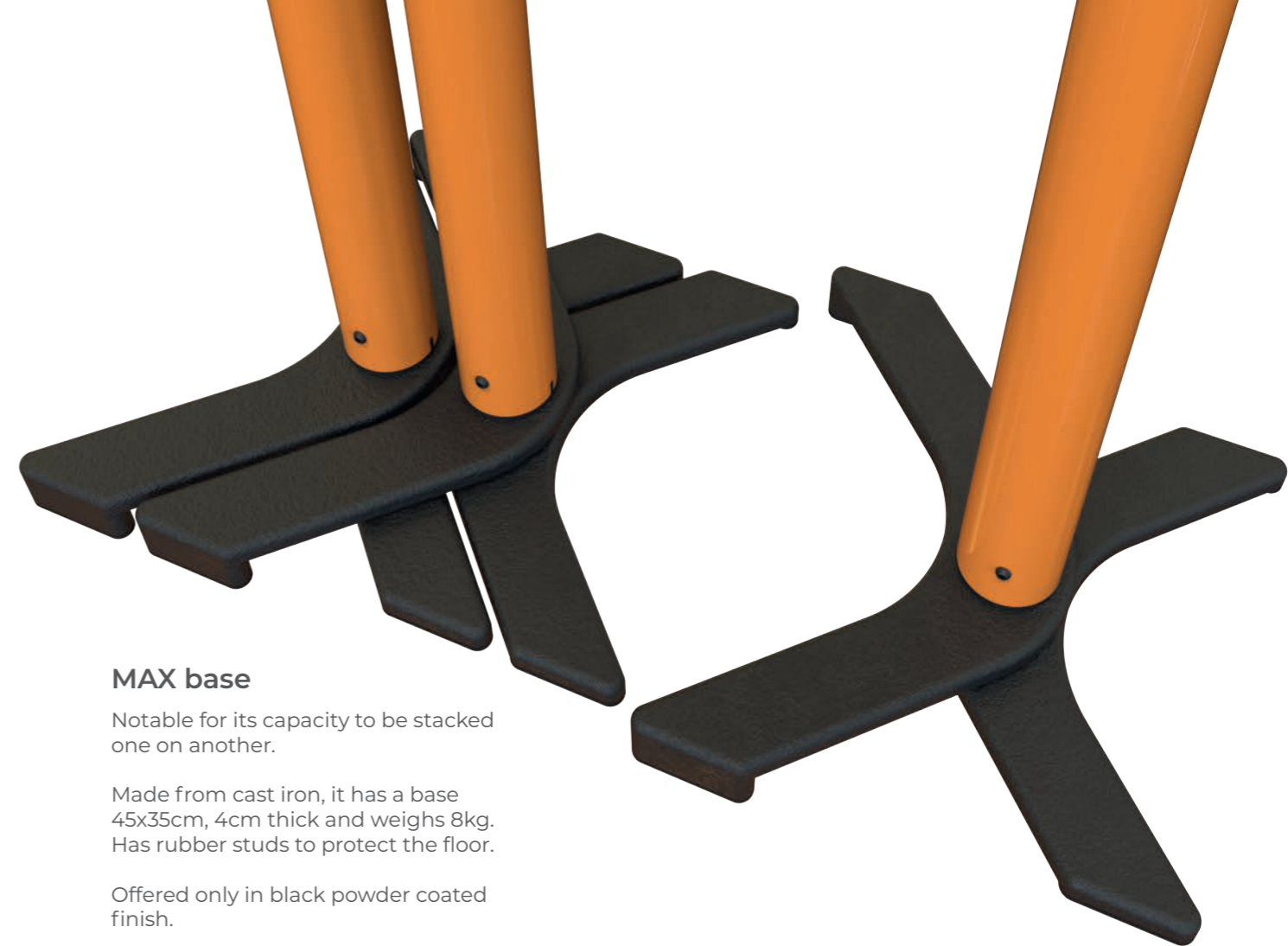

MAX base

Notable for its capacity to be stacked one on another.

Made from cast iron, it has a base 45x35cm, 4cm thick and weighs 8kg. Has rubber studs to protect the floor.

Offered only in black powder coated finish.

MAX base

Our stackable base

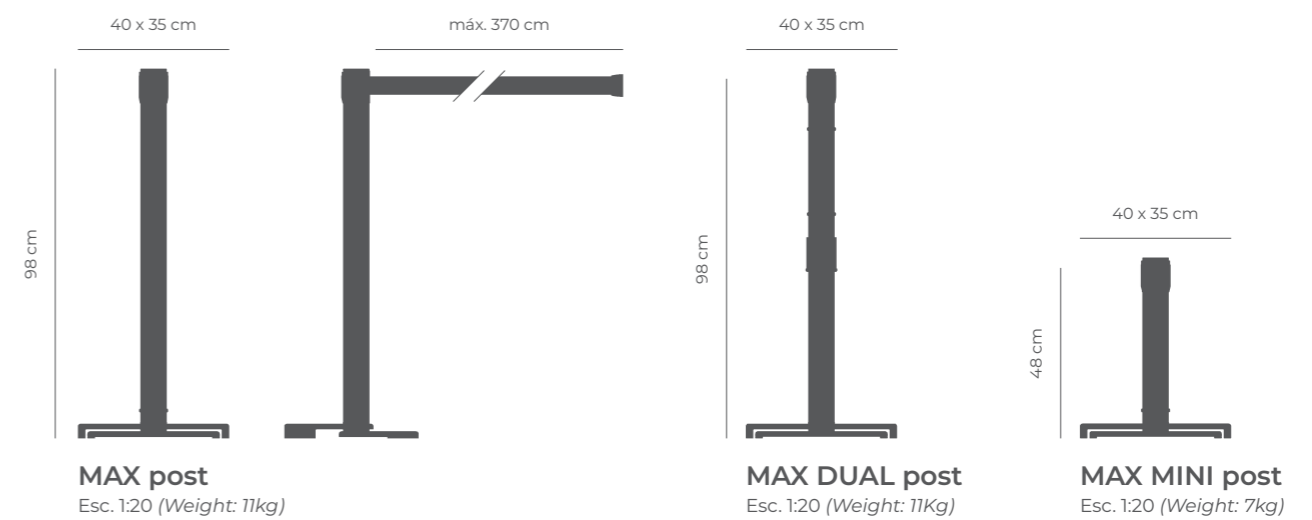



FIX base

This is a fixed mounted base, screwed directly into the floor.

Made from recycled PP, base diameter Ø13.5cm, 2 cm thickness, 1kg weight.

The upper surface is a cover hiding the fixing screws. The cover is recycled PP, pressure fitted and does not require adhesives. Offered in black.

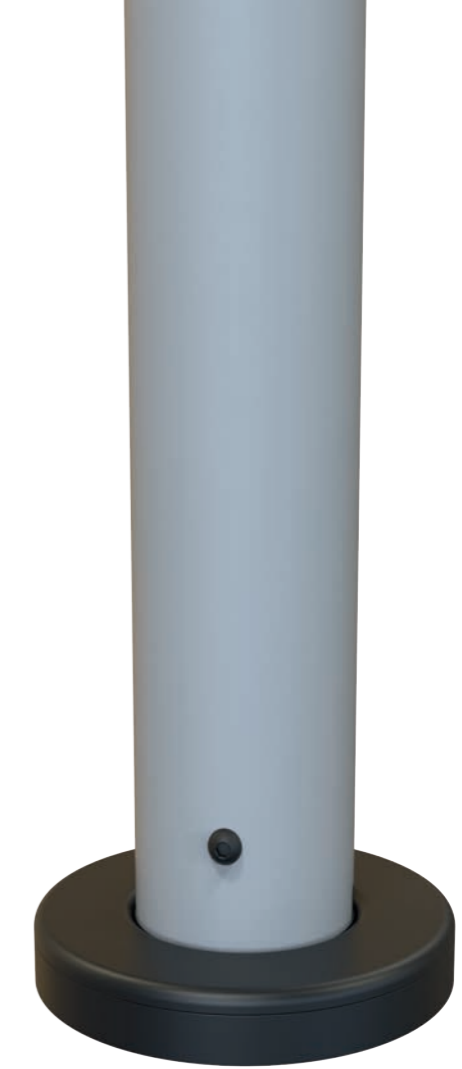

FIX base

Base for fixed installations.

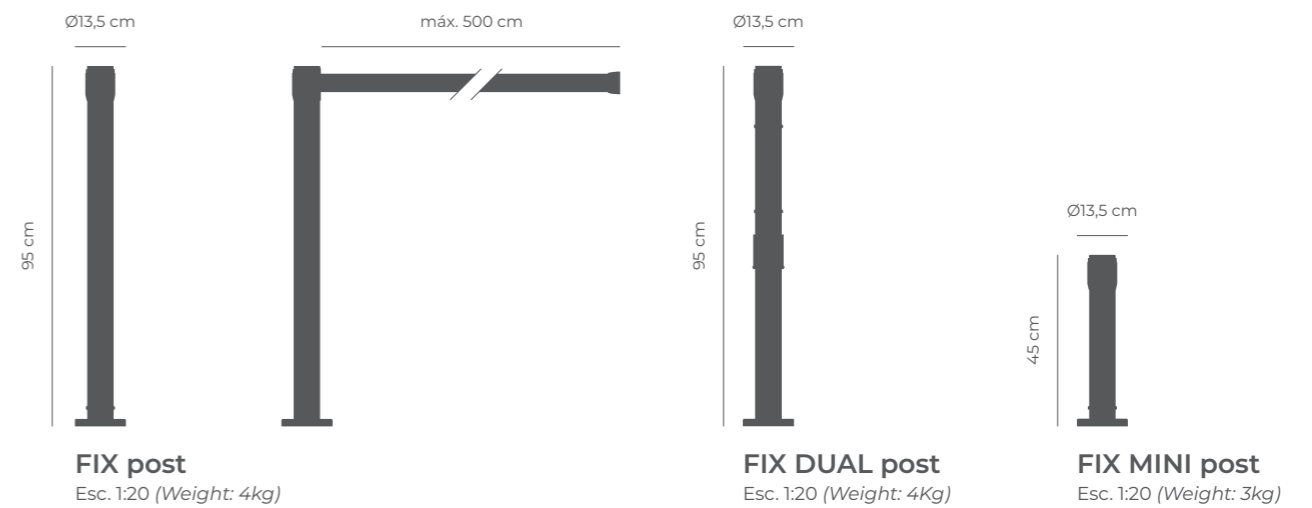



UNFIX base

This model is both recessed and removable.

Aluminium construction. It diameter $\varnothing 7$ cm, 0.5 cm thickness and weighs 1 kg.

Installed in a hole in the ground and then screwed directly.

Once installed it may be removed and reinserted as many times as required.

A flat aluminum plug is included to cover the hole when the tube is not present.



UNFIX base

Base for removable installations at fixed points.

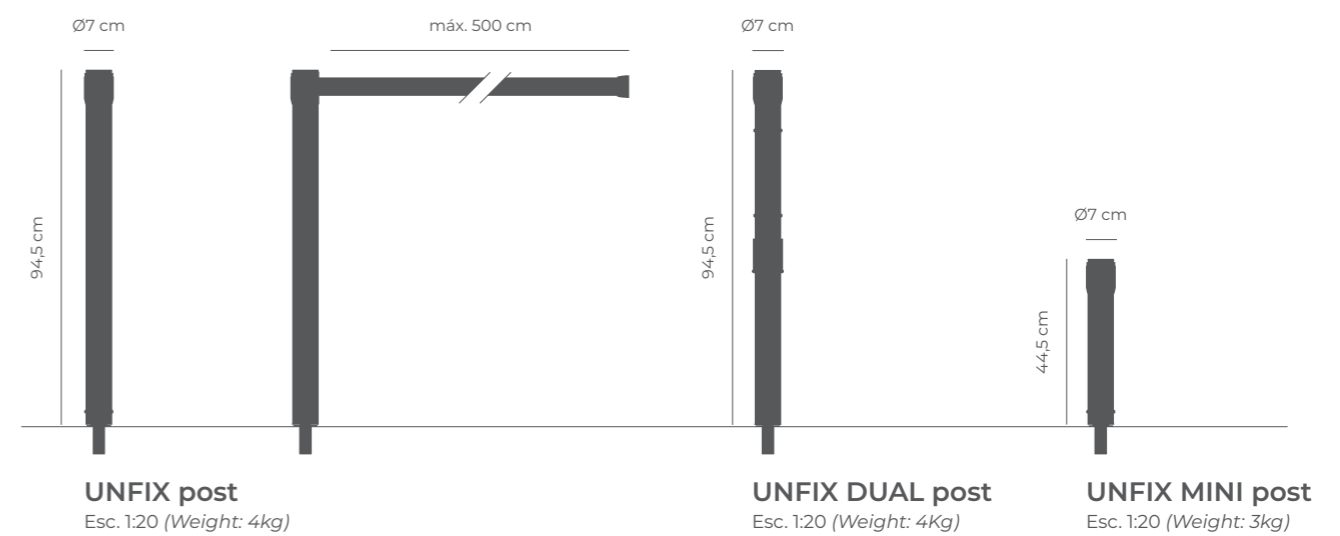



BASIC wall

Wall elements for any installation.



BASIC wall

The BASIC Wall is our best-selling wall element to date.

In its two installation options, horizontal and vertical, tape reels of up to 3.7 m are mounted.

These tapes can be customized. Very versatile and very discreet painted in black.



BASIC wall

Esc. 1:10 (Weight: 1kg)

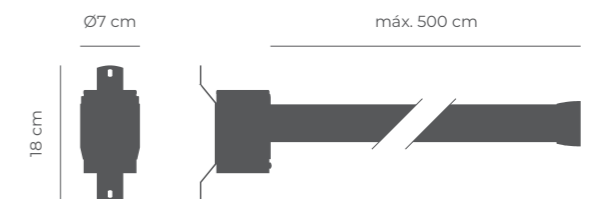

Vertical BASIC wall

Esc. 1:10 (Weight: 1Kg)



FIX wall / DUAL wall

Special wall elements.



FIX wall

The FIX wall is our recessed installation wall element. Due to its characteristics, it is suitable for installation on any type of wall.

This wall element has a tape up to 5m. These ribbons can be personalized.

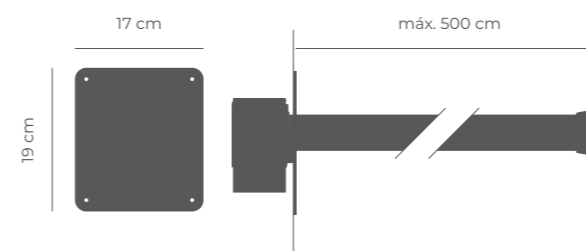

FIX wall

Esc. 1:10 (Weight: 1kg)

DUAL wall

This wall element is characterized by mounting two reels of up to 5 meters. These tapes can be customized, just like the color of the paint.

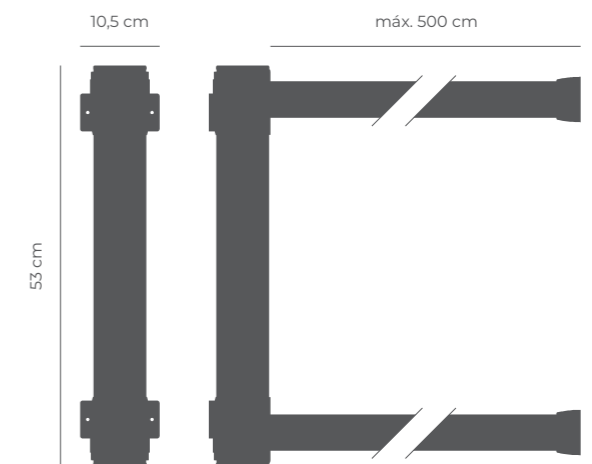

DUAL wall

Esc. 1:10 (Weight: 2Kg)



STANDARD wall

Wall elements with long ribbons.



STANDARD wall

The Standard wall is our latest invention. Inconspicuous in appearance, this plastic capsule withstands impact and thousands of cycles of tape stretching.

Available in two models of different sizes and tape lengths. This wall element stands out for the length of its ribbons. These ribbons may be personalized.



STANDARD wall (5m)

Esc. 1:10 (Weight: 1kg)



STANDARD wall (7m)

Esc. 1:10 (Weight: 1,5kg)



METAL wall

Wall element shrouded in metal.

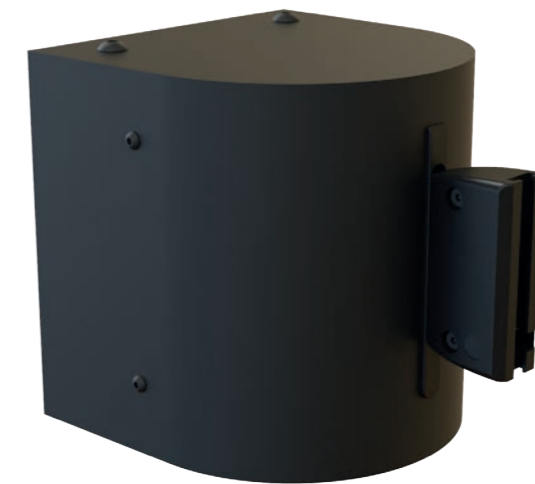

METAL wall

This is our most classic wall element. A powder-coated metal casing covers the entire mechanism completely, leaving only the tape terminal in view. This ribbon can be personalized.



METAL wall (5m)

Esc. 1:10 (Weight: 1kg)



TROLLEY

To transport many posts together.

Post carrier trolley

Our TROLLEY is designed as a steel and aluminum frame resting on heavy-duty, industrial grade rubber wheels.

Carries up to 15 round base posts.
Extremely stable and easy to handle.



TROLLEY
Esc. 1:20 (Weight: 40kg)



Notice holder

Two models for all need.

Choose your look

Here are the two poster holders from the Dlimit™ collection.

1. BASIC. The more discreet of the two. Can tilt and face the user.

2. ECHO. The simplest and cheapest. Place your folder on a die-cut handrail. This model is available in 2 sizes (A4 / A3) and in two orientations (Portrait / Landscape).

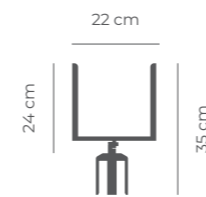

Notice holder BASIC A4 V
Esc. 1:20 (Weight: 0,7kg)

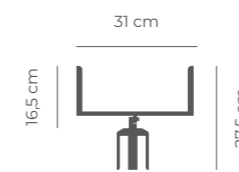

Notice holder BASIC A4 H
Esc. 1:20 (Weight: 0,7kg)

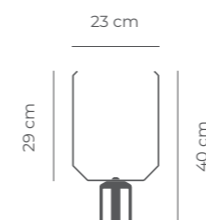

Notice holder ECO A4 V
Esc. 1:20 (Weight: 0,7kg)

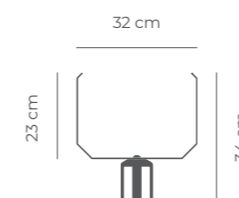

Notice holder ECO A4 H
Esc. 1:20 (Weight: 0,7kg)

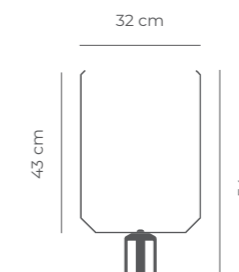

Notice holder ECO A3 V
Esc. 1:20 (Weight: 1kg)

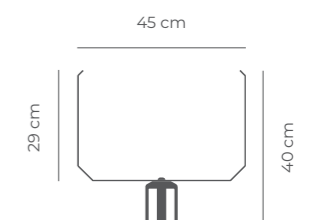

Notice holder ECO A3 H
Esc. 1:20 (Weight: 1kg)



Surface finishes

Our posts come in three finishes possibilities: Powder-coated iron, stainless steel and anodized aluminium.

Powder coated iron

With this industrial technique we can paint the iron tubes in any color from the RAL® chart. The paint adheres to the tube using electromagnetic charge and is then baked. The result is an ultra-resistant ceramic finish paint.



Stainless Steel

One of the most used materials in industry and in architecture owing to its unbeatable performance. We offer stainless steel with a satin finish. It has a spectacular appearance and better resists the passage of time.

Anodized Aluminium

Thanks to its specific properties, aluminum can be anodized. This top quality finish gives color and texture to the material. It also protects aluminum for a long period of time.

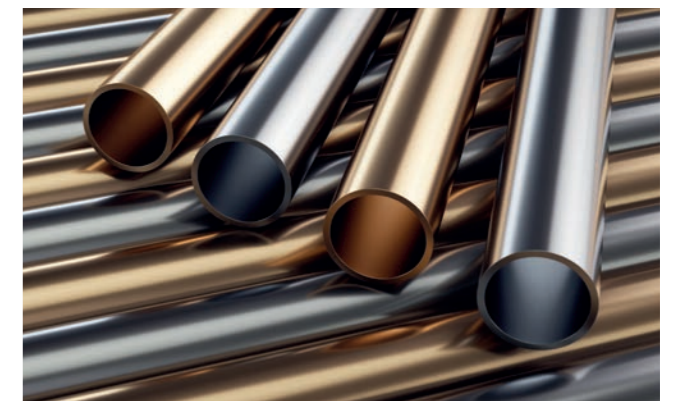



Promote your brand with us

All our belts are customisable. Through sublimation we achieve extraordinary quality custom made for each client.

Publicity and marketing

The barriers are a great space for publicity. People stand next to them for some time and so we understand the importance and potential of correct personalisation as part of your marketing.



Security messages

In the workplace there is the need to communicate information about safety regulations e.g. no entry, danger of falling materials, slippery surfaces, emergency exits etc. Send us your design or ask to see our standard products.

PANTONE® colours

All our designs are printed using a 4 colour space (CMYK) allowing us to print any colour you require from any catalogue or palette. If you need a belt in your company's colour or any other colour imaginable we can make it for you.



Medidas generales

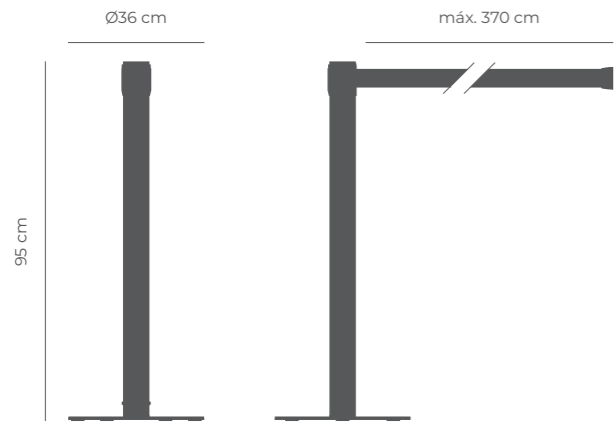

LIMIT post
Esc. 1:20 (Weight: 11kg)

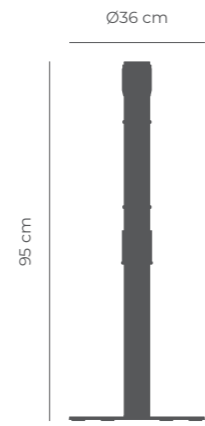

LIMIT DUAL post
Esc. 1:20 (Weight: 11Kg)

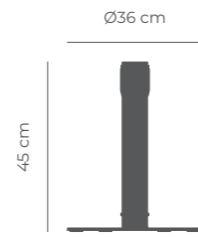

LIMIT MINI post
Esc. 1:20 (Weight: 7kg)

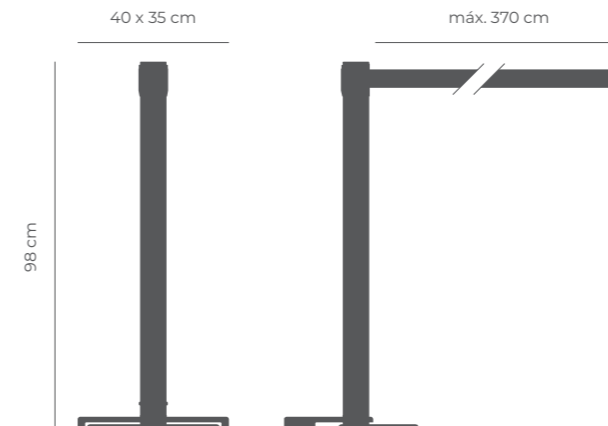

MAX post
Esc. 1:20 (Weight: 11kg)

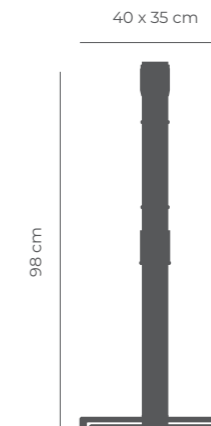

MAX DUAL post
Esc. 1:20 (Weight: 11Kg)

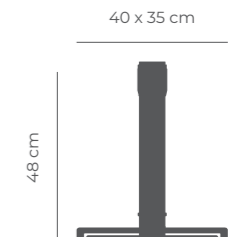

MAX MINI post
Esc. 1:20 (Weight: 7kg)

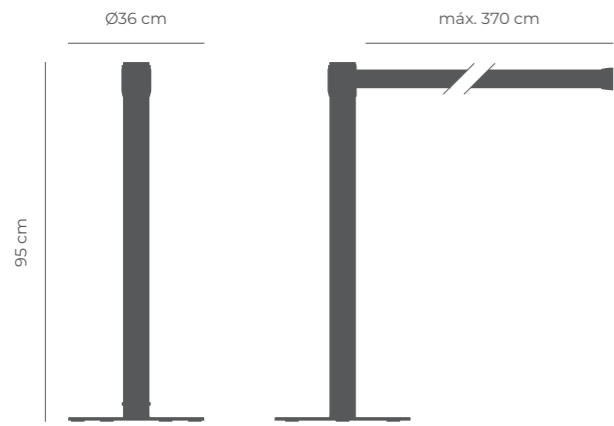

ECO post
Esc. 1:20 (Weight: 8kg)

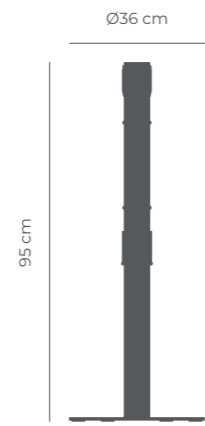

ECO DUAL post
Esc. 1:20 (Weight: 8Kg)

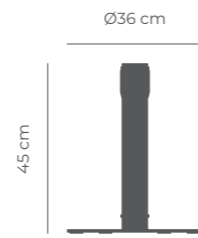

ECO MINI post
Esc. 1:20 (Weight: 4kg)

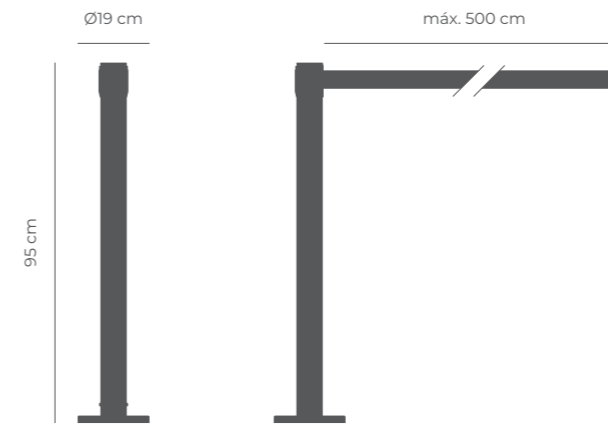

FIX post
Esc. 1:20 (Weight: 4kg)

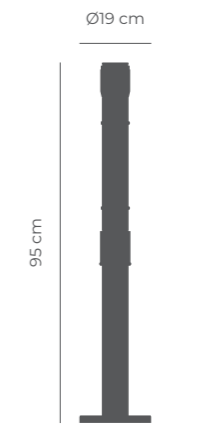

FIX DUAL post
Esc. 1:20 (Weight: 4Kg)

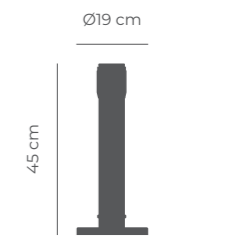

FIX MINI post
Esc. 1:20 (Weight: 3kg)

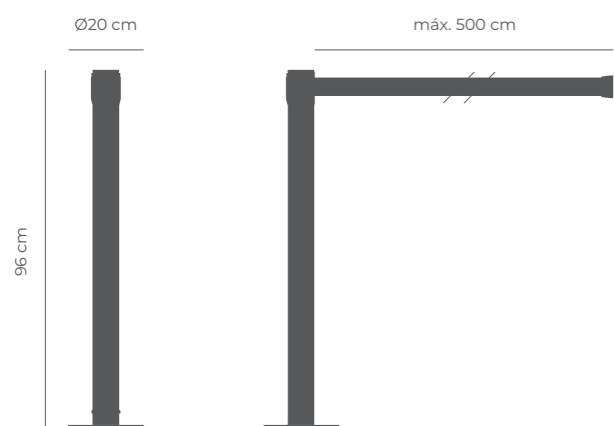

MAG post
Esc. 1:20 (Weight: 4kg)

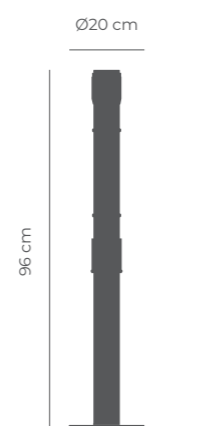

MAG DUAL post
Esc. 1:20 (Weight: 4Kg)

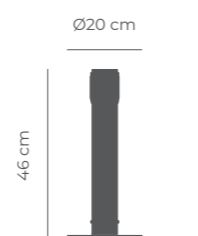

MAG MINI post
Esc. 1:20 (Weight: 3kg)

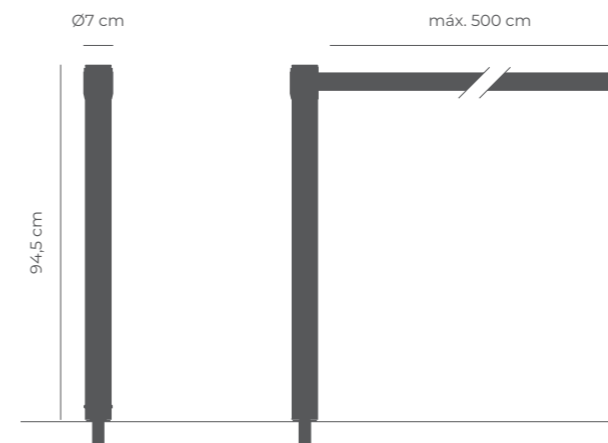

UNFIX post
Esc. 1:20 (Weight: 4kg)

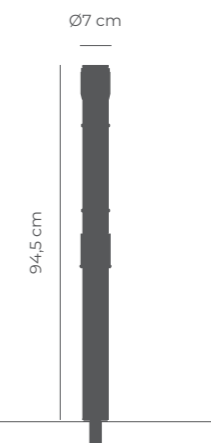

UNFIX DUAL post
Esc. 1:20 (Weight: 4Kg)

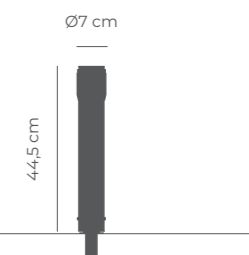

UNFIX MINI post
Esc. 1:20 (Weight: 3kg)

Medidas generales



BASIC wall
Esc. 1:10 (Weight: 1kg)

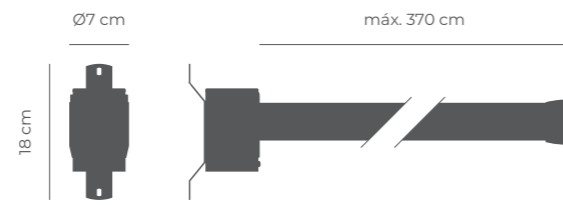

Vertical BASIC wall
Esc. 1:10 (Weight: 1Kg)



STANDARD wall (5m)
Esc. 1:10 (Weight: 1kg)



STANDARD wall (7m)
Esc. 1:10 (Weight: 1,5kg)



METAL wall (5m)
Esc. 1:10 (Weight: 1kg)

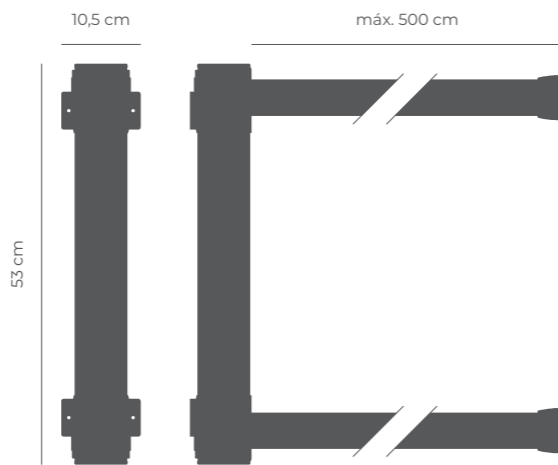

DUAL wall
Esc. 1:10 (Weight: 2Kg)

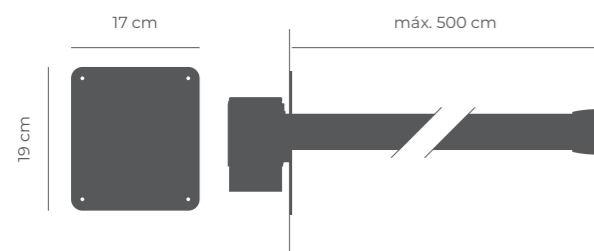

FIX wall
Esc. 1:10 (Weight: 1kg)

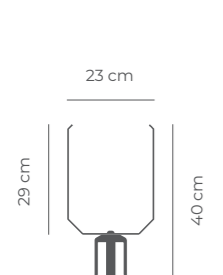

Notice holder ECO A4 V
Esc. 1:20 (Weight: 0,7kg)

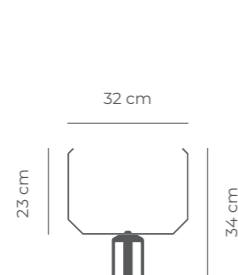

Notice holder ECO A4 H
Esc. 1:20 (Weight: 0,7kg)

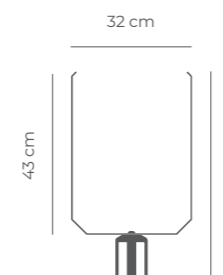

Notice holder ECO A3 V
Esc. 1:20 (Weight: 1kg)

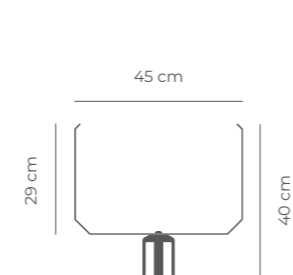

Notice holder ECO A3 H
Esc. 1:20 (Weight: 1kg)



TROLLEY
Esc. 1:20 (Weight: 40kg)

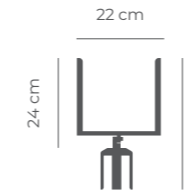

Notice holder BASIC A4 V
Esc. 1:20 (Weight: 0,7kg)

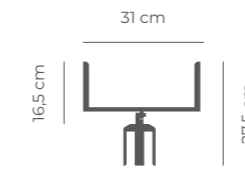

Notice holder BASIC A4 H
Esc. 1:20 (Weight: 0,7kg)

Post colours



Post finishes

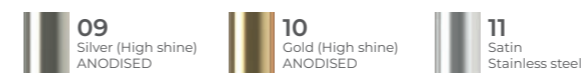

Belt colours

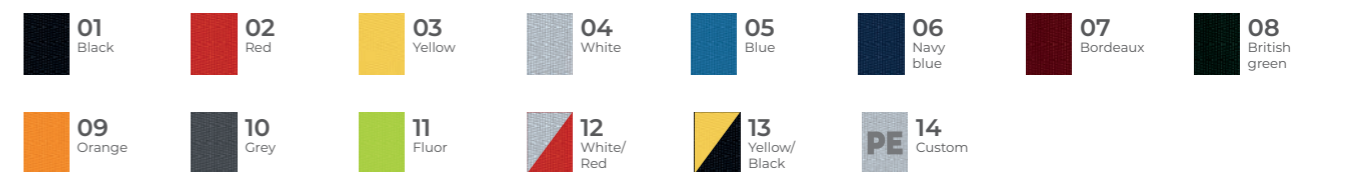

DLIMIT™ SPAIN

www.dlimit.net
info@dlimit.es
Telf. (+34) 932.74.34.90
C/ Alcalde Josep Abril 30
08302 Mataró

DLIMIT™ FRANCE

www.dlimit.net
contact@dlimitfrance.fr
Telf. (+33) 06.20.73.38.48
8 Avenue Emile Aillaud
91350 Grigny

DLIMIT™ ITALY

www.dlimit.net
ilaria@dlimit.es
Telf. (+39) 023.055.17.53
Cell. (+34) 610.63.93.37

DLIMIT™ PORTUGAL

www.dlimit.net
carla.lains@cdla.pt
Telf. (+351) 934.922.825
Rua Gonçalves Zarco, 1129-B
Edifício Zarco – Bloco B – sala 115
4450-685 Matosinhos (Portugal)

DLIMIT™ BELGIUM

www.potelet.eu
info@potelet.eu
Telf. (+32) 87.84.10.20
Rue Mitoyenne, 414
4710 Lontzen (Belgique)

Specialists in safer public environments.

DLIMIT™

(*)DLIMIT™ applies a policy of continuous development of its products and reserves the right to make changes on the specifications, colors and prices, without prior notice. For this reason, no rights can be derived based on the data, images and descriptions in this document. This product and all its components, as well as the original spare parts, have been manufactured in accordance with the Legal Regulations aimed at preventing and minimizing the impact on the environment, through the use of recycled/recyclable materials, and adopting measures aimed at achieve adequate recycling for the conservation and improvement of environmental quality.

Due to limitations in the printing process, colors reproduced in this catalog may vary slightly from actual colors and materials. Reprinting, reproduction or translation, in whole or in part, is not permitted without the written permission of DLIMIT™. DLIMIT™ expressly reserves all rights under the law on the "Copyright".

The paper we use is FSC® certified. See full terms and conditions at www.dlimit.net