

DUAL

DSA-D-XX-XX



Materiales

- CABEZAL** PA Reciclado al 100%
- POSTE** PVC Reciclado al 100% (Relleno de SBR 100% reciclado)
- BASE** PP reciclado al 100%

Características Generales

-  **Peso:** **11,5 kg**
-  **Longitud de cinta:** **10 m**











Características Técnicas

-  Freno en recogida
-  Autorecogida de cinta
-  Bloqueo de cinta
-  Estabilidad
-  Resistente a impactos
-  Opciones de color

Colores del poste

- | | | | |
|---|--|--|--|
|  01
Negro
RAL 9005 |  02
Rojo
RAL 3020 |  03
Amarillo
RAL 1018 |  04
Blanco
RAL 9003 |
|---|--|--|--|

Colores de cinta

- | | | | |
|--|---|--|---|
|  01
Negro |  02
Rojo |  03
Amarillo |  04
Blanco |
|  05
Azul |  06
Verde | | |
|  07
Blanco/
Rojo |  08
Amarillo/
Negro |  09
Blanco/
Azul |  10
Blanco/
Verde |

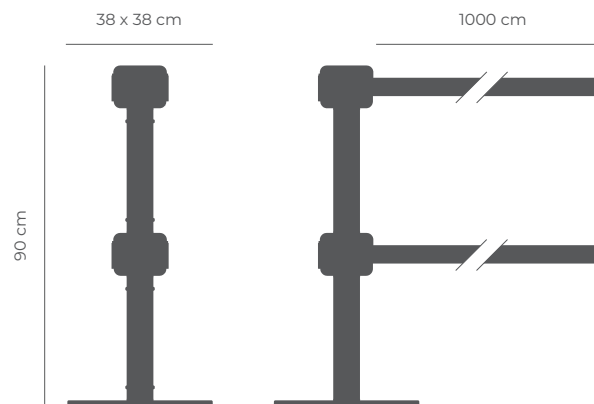

DUAL

Esc. 1:20 (Peso: 11,5kg)